

cod. 46.0430.000



SIM2 Grand Cinema HT

*User and Installation Manual
The home theater projector*

HT500E



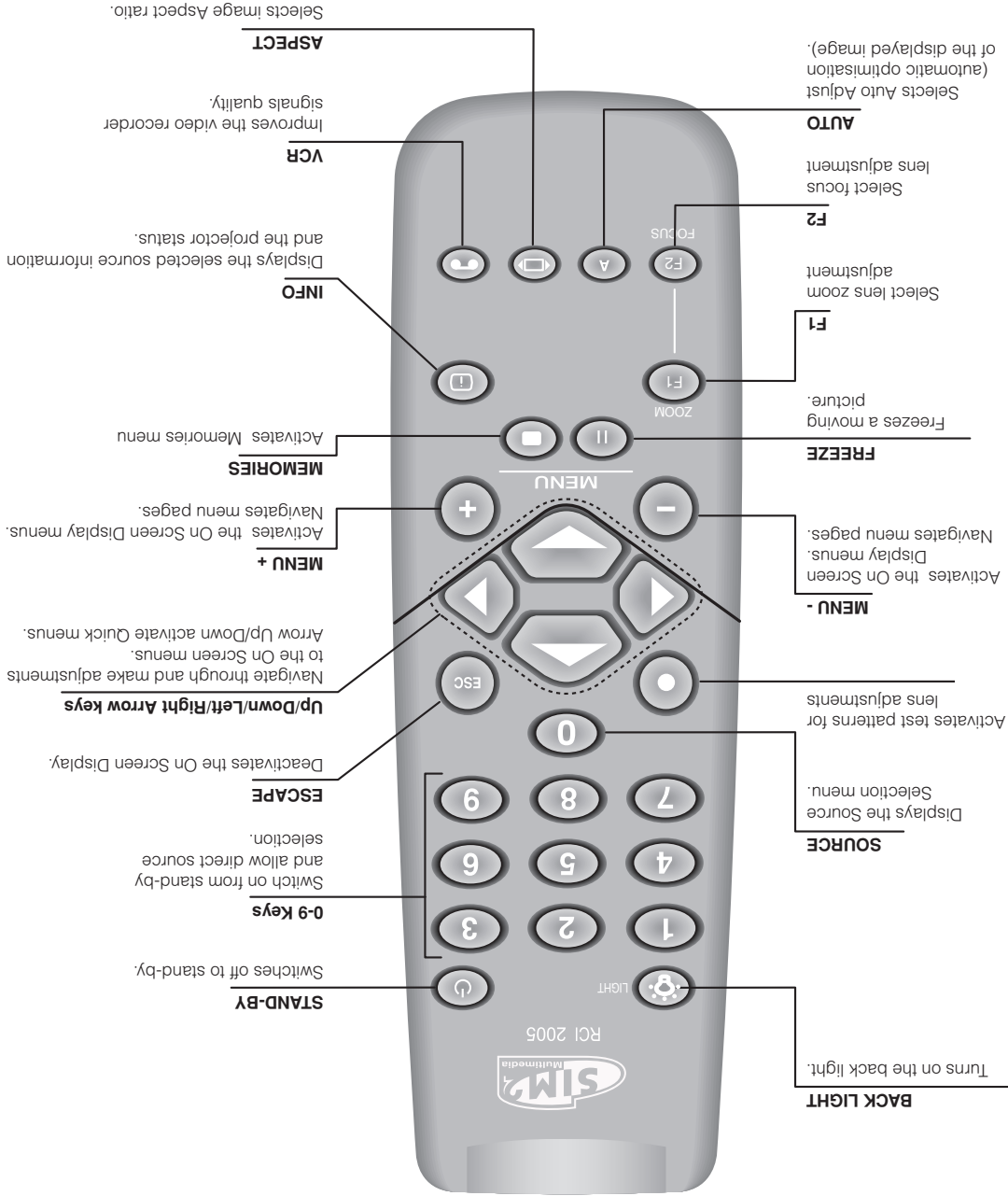

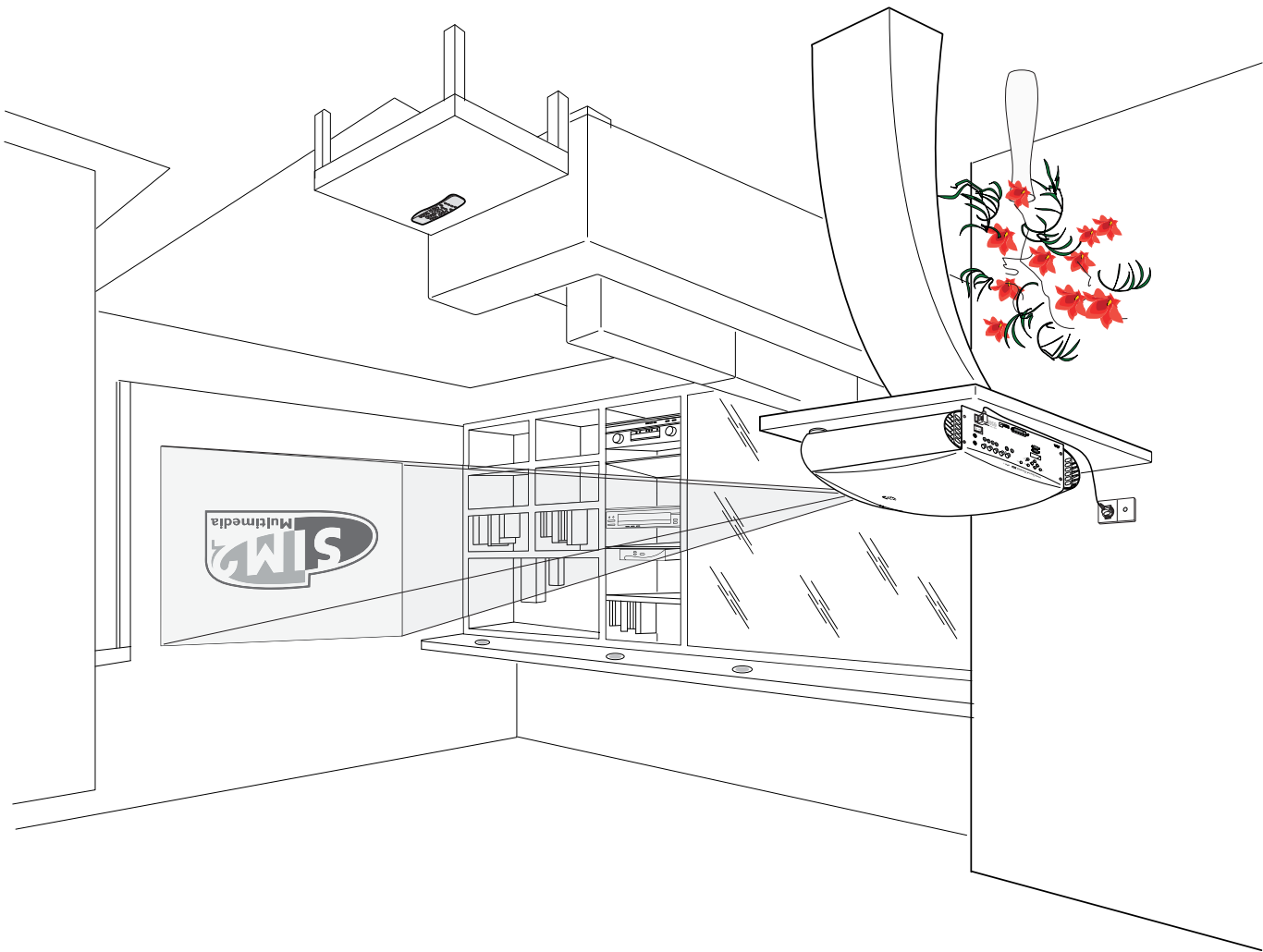

Congratulations on your choice of the SIM2 Grand Cinema HT500E system!

1 INTRODUCTION

Using the very latest in DLP™ technology, this projector has been designed specifically for high quality "Home Cinema" applications.

The large number of inputs available (1 Composite Video inputs, 1 S-Video inputs, 2 Component or RGB inputs, 1 graphic RGB inputs, 1 DVI-D input, 1 HDMI™ Input) ensures the system supports a wide variety of analogue and digital sources: DVD players, VCRs, satellite and terrestrial receivers, computers, game consoles, video cameras, etc.

The signal processing capabilities of the Image Processor ensure optimum reproduction of a broad range of input signals, from interlaced video to high definition and graphics.

Conversion of interlaced video signals to progressive signals by means of prestigious DCD!™ technology produces fluid, natural, images free of flicker and stairstepping artefacts.

Faithful reproduction of signals at higher resolutions (such as high definition video and graphics) occurs without loss of information or reduction of image sharpness thanks to the processor's high pixel rate signal acquisition capabilities.

Adaptation of the input signal resolution to the Projector resolution occurs without alterations of image quality, in accordance with an ample choice of aspect ratios, including several def-

nable by the user.

All image adjustments can be performed with the remote control with the aid of the *On Screen Display*; alternatively, the unit can be controlled by from a home automation system through the serial port.

Thanks to the new optical system based on three chip DMD™, the HT500E allows to take advantage from DLP™ technology, the Texas Instruments technology. Each of the three DMD™ chip is dedicated to the modulation of one of the primary colors coming from the optical prism, the reflected light, after combination by a second prism, is projected outside using an appropriate lens system. The technology of the HT500E allows to obtain images without rainbow effect or any other type of artefact, in order to enjoy an even more realistic images.

SIM2 carries out comprehensive functional testing in order to guarantee the maximum product quality. For this reason, when you start using the product lamp operating hours may already be at between 30 and 60. In addition to the regular tests, the Quality Control department performs additional statistical tests at the time of shipment. In this case the packing may show signs of having been opened, and the accumulated lamp operating hours may be slightly higher than the hours associated with the standard tests.



DLP and DMD are registered trademarks of Texas Instruments. DCD! is a registered trademark of Faroudja, a division of Genesis Microchip, Inc. HDMI, the HDMI logo and High-Definition Multimedia Interface are trademarks or registered trademarks of HDMI Licensing LLC

2 IMPORTANT SAFETY INSTRUCTIONS

ATTENTION:

To reduce the risk of electric shock, disconnect the power supply cable on the rear panel before removing the top cover of the projector. Refer to trained, authorised personnel for technical assistance.

This symbol indicates the possible electric shock hazard associated with uninsulated live components in the interior of the unit.



This symbol indicates the presence of important instructions regarding use and maintenance of the product.

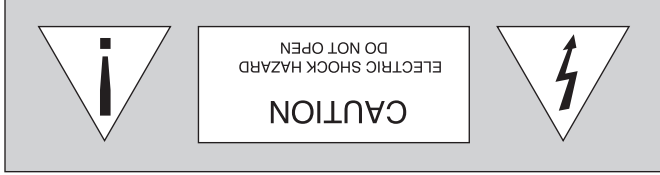

LAMP WARNING

If the lamp should suddenly break with a loud bang, air the room thoroughly before using it.
Do not replace the lamp: seek qualified technical assistance from your nearest Dealer.

Prior to switching on the projector please read each chapter of this manual carefully as this manual provides basic instructions for using the projector.
The installation of the lamp assembly, preliminary adjustments and procedures that necessitate the removal of the top cover, must be carried out by authorised, trained technicians. There are no user serviceable parts inside. To ensure safe and long term reliability please use power cables supplied with the projector. Observe all warnings and cautions.

• Federal Communication Commission (FCC Statement)
This equipment has been tested and found to comply with the limits for a Class B digital device, pursuant to Part 15 of the FCC rules. These limits are designed to provide reasonable protection against harmful interference when the equipment is used in a commercial environment. This equipment generates, uses and can radiate radio frequency energy and, if not installed and used in accordance with the instruction manual, may cause harmful interference to radio communications. However, there is no guarantee that interference will not occur in a particular installation. If this equipment does cause harmful interference to radio or television reception, which can be determined by turning the equipment off and on, the user is encouraged to try to correct the interference by one or more of the following measures:

- Reorient or relocate the receiving antenna
- Increase the separation between the equipment and receiver.
- Connect the equipment into an outlet on a circuit different from that to which the receiver is connected.
- Consult the dealer or an experienced radio/TV technician for help.

• For customers in Canada

This Class B digital apparatus complies with Canadian ICES-003.

• For customers in the United Kingdom

ATTENTION: This apparatus must be earthed
The wires in this mains lead are coloured in accordance with the following code:
Green-and-Yellow: Earth
Blue: Neutral
Brown: Live

As the colours of the wires in the mains lead of this apparatus may not correspond with the coloured markings identifying the terminals in your plug proceed as follows:
The wire which is coloured green-and-yellow must be connected to the terminal in the plug which is marked by the letter E or by the safety earth symbol \equiv or coloured green or green-and-yellow.
The wire which is coloured blue must be connected to the terminal which is marked with the letter N or coloured black.
The wire which is coloured brown must be connected to the terminal which is marked with the letter L or coloured red.

PROJECTOR

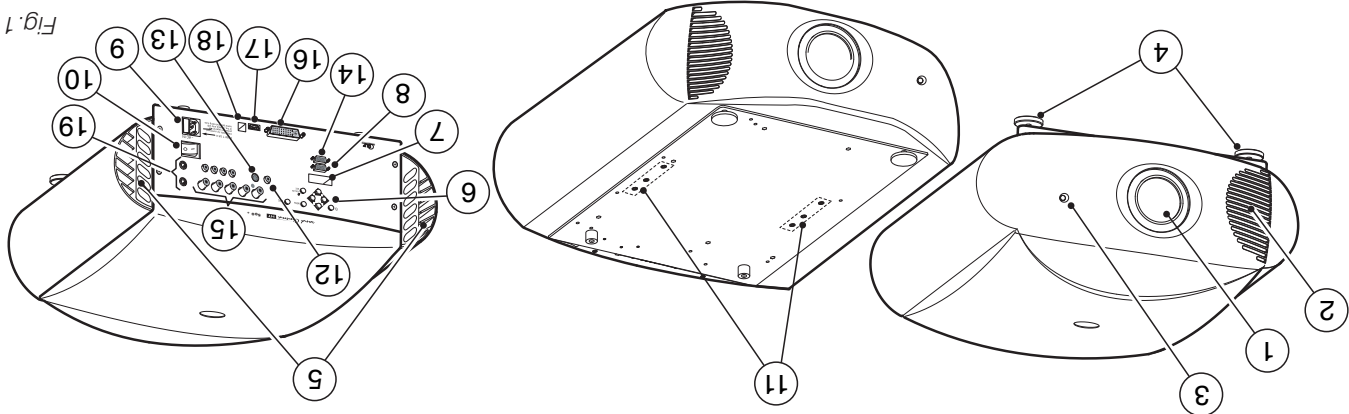

- 1 Projection lens
- 2 Cooling air inlet vents
- 3 Remote control IR sensor
- 4 Adjustable levelling feet
- 5 Cooling air outlet vents
- 6 Main function keys
- 7 Remote control rear IR sensor and indicator for LED
- 8 Serial interfaces RS232
- 9 Fused power socket
- 10 Main power switch
- 11 Ceiling bracket fixing holes
- 12 Composite video input
- 13 S-Video input
- 14 VGA input
- 15 RGB / YCrCb input
- 16 DVI-D input
- 17 HDMI™ input
- 18 Audio Output
- 19 12Vdc screen output

Fig. 1

Read this manual carefully and keep it in a safe place for future consultation.

This manual contains important information on how to install and use this equipment correctly. Before using the equipment, read the safety prescriptions and instructions carefully. Keep the manual for future consultation.

Do not touch internal parts of the unit.

The unit contain electrical parts carrying high voltages and operating at high temperatures. Do not remove the cover from the unit, refer to qualified service personnel for all repair and maintenance requirements. The warranty will be automatically invalidated if the cover is removed from the unit.

Power supply disconnect device.

The device for disconnecting the units from the mains power supply is constituted by the power cable plug. Ensure that the power cable plugs and the electrical mains socket outlets are easily accessible during installation operations. To disconnect the unit from the electric power supply, pull the plug to remove it from the socket outlet. Do not pull the power cable.

Connect the unit to a mains electrical supply

Make the connection as shown in Fig.2

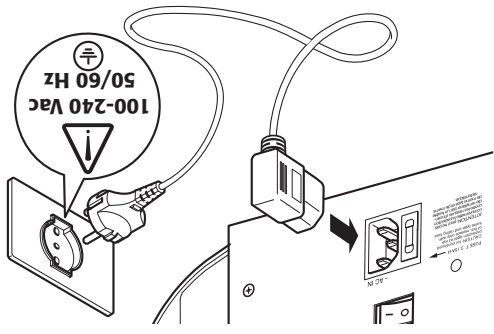

Fig.2

Connect the units to a mains electrical supply with rated voltage of between 100-240 VAC, 50/60 Hz and equipped with a protective earth connection. If you are unsure of the type of mains power supply in your home, consult a qualified electrician. Ensure that the power draw of the units is commensurate with the rating of the electrical socket outlets and any extension cables that are used.

Prevent the unit from overheating. In order to allow the Projector cooling, keep at least 40 cm (16") of space between the rear of the projector and the nearest wall or obstruction. Do not place the devices near heat sources such as heaters, radiators or other devices that generate heat (including amplifiers). Do not obstruct ventilation openings. Do not place the unit in confined, poorly ventilated positions (bookcases, shelves, etc.).

Do not expose the eyes to the intense light emitted by the lamp. Never look directly at the lamp through the ventilation opening when the unit is switched on. Risk of eyesight impairment. Ensure also that children do not look directly at the lamp.

Beware of the lens movements Avoid positioning objects close the lens. The movements (horizontal and vertical) could be obstructed by objects, or damage may arise from the fall of the objects.

Position the unit on a stable surface. To avoid serious injury to persons and damage to property, make sure the units are placed on a level, flat and stable surface from which they cannot fall, tip over or slide. Pay special attention if the units are placed on a trolley so that they can be moved around. Ensure that the units are not subjected to impact.

Do not insert objects through the unit openings. Make sure that no objects are inserted inside the units. If this should occur, disconnect the unit from the power supply immediately and call an authorised technician.

Energy Saving When the system is left idle for a long period disconnect the Projector from the main power supply. This precaution allows to save energy and to prevent wear and tear of the electronics devices.

Replace the safety fuse Before making the replacement disconnect the appliance from the mains power supply. The fuse compartment is close to the mains power connector (Fig. 3). Use a slotted screwdriver to remove the fuse carrier (2) and replace the fuse (3). Insert a new spare fuse (4). Use only T 5A H fuses.

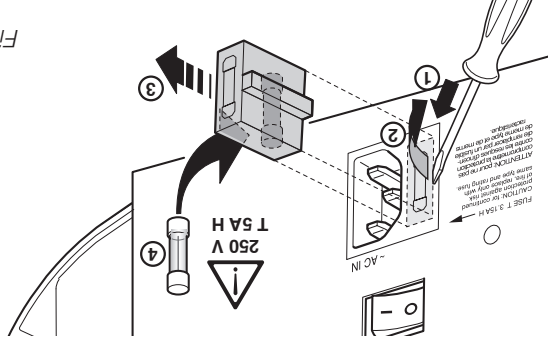

Beware of power supply cables. Position the power supply cables so that they do not constitute an obstruction. Position the power supply cables where they cannot be reached by children. Install the units as close as possible to the wall electrical socket outlet. Do not read on the power cables, make sure that they are not tangled or pulled; do not expose the power cables to heat sources; make sure that the power cables do not become knotted or kinked. If the power cables become damaged, stop using the system and request the assistance of an authorised technician.

Disconnect the apparatus from the mains power supply in the event of electrical storms and when not in use. To avoid damage that could be caused by lightning striking in the vicinity of your home, disconnect the unit in the event of electrical storms or when the system will remain unused for prolonged periods.

Avoid contact with liquids and exposure to humidity. Do not use the unit near water (sinks, tanks, etc.); do not place objects containing liquids on top of or near the unit and do not expose them to rain, humidity, dripping water or spray; do not use water or liquid detergents to clean the unit.

3 UNPACKING

To unpack the projector safely and easily please follow steps 1 to 5, as per drawing (Fig. 4). It is recommended that the carton and packaging is retained for future use and in the unlikely event that your projector needs to be returned for repair.

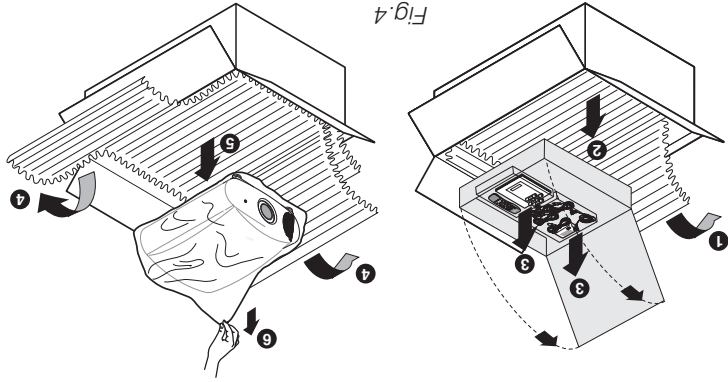

Fig.4

PACKAGE CONTENTS

The carton should contain the following:

- the projector
- the remote control
- four 1.5V AAA batteries (for remote control)
- three power cables for the projector (EU, UK, USA)
- one cable HDMI™-HDMI™
- one cable HDMI™-DVI
- the user and installation manual.

If any accessories are missing, contact your Dealer as soon as possible.

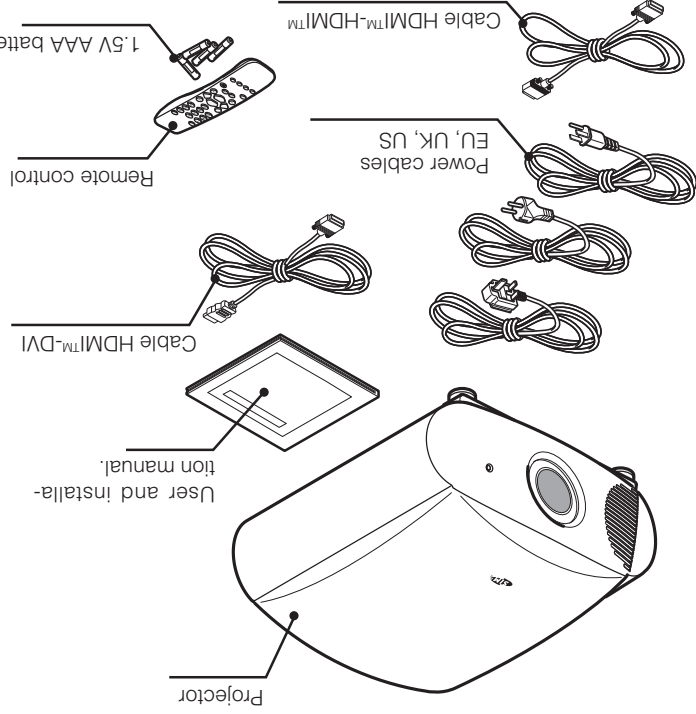

Fig.5

Position the projector on a stable, suitable platform or utilise the optional bracket for a fixed ceiling or wall installation.

CAUTION: In the case of ceiling or wall mounting using a suspension bracket, follow the instructions carefully and comply with the safety standards you will find in the box together with the bracket. If you use a bracket different to the one supplied by SIM2 Multimedia, you must make sure that the projector is at least 65 mm (2-9/16 inch) from the ceiling and that the bracket is not obstructing the air vents on the lid and on the bottom of the projector.

Adjust the feet underneath to obtain a level position, lining up the base of the projected image to the base of the projection screen (Fig. 6).

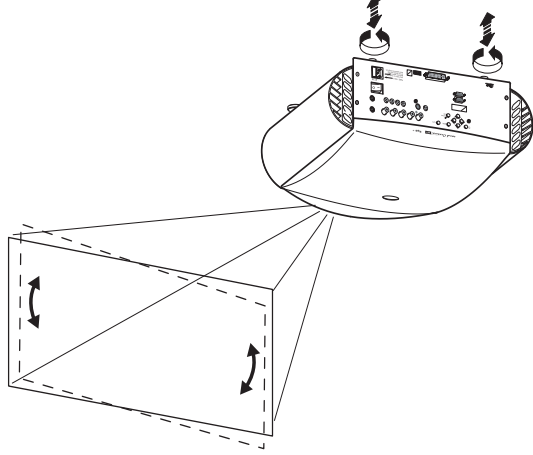

Fig. 6

Position the projector the desired distance from the screen: the size of the projected image is determined by the distance from the lens of the projector to the screen and the zoom setting. See "Appendix C"; "Projection distances" for more information.

Use the motorised lens zoom to adjust the image size and the motorised lens focus to achieve maximum clarity.

With optimum focus you should be able to clearly see each single pixel when within close proximity to the screen (Fig. 7).

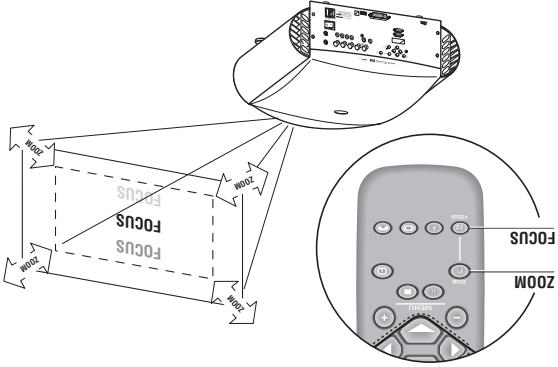

Fig. 7

The manual lens shift adjustment allows the projected image to be moved vertically, up or down, in relation to the centre of the screen; the maximum adjustment being equal to half the height of the image in either direction (Fig. 8).

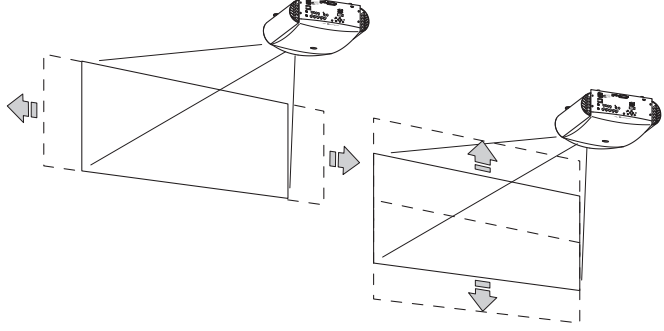

Fig. 8

In the event you are unable to centre the image within the screen area, tilt the projector until the image is correctly positioned.

Any keystone error can be removed by the Keystone adjustment in the Set up menu (Fig.8a).

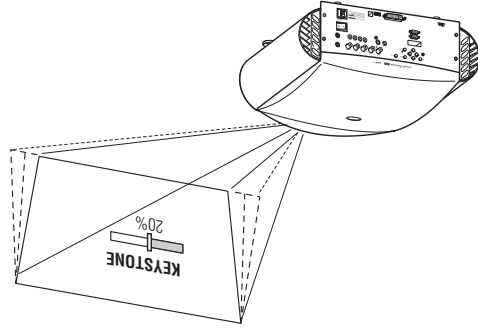

Fig. 8a

The Orientation adjustment in the Set up menu will allow the projector to be used for desktop front, ceiling front, desktop rear and ceiling rear installations (Fig. 9).

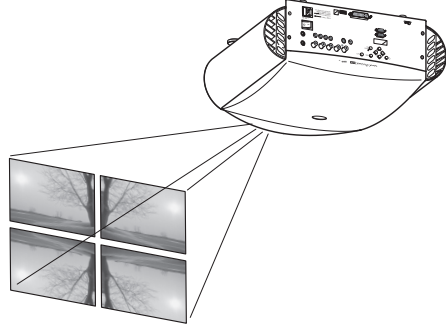



Fig. 9

To activate an electric motorised screen a 12 Volt output is provided at the rear of the projector. This can be connected to a screen interface unit, which can be supplied by screen manufacturers (Fig. 10). The output is activated (Voltage: 12 Vdc) when the projector is switched on and is de-activated (no Voltage output) when the projector is in stand-by mode. Some manufacturers offer screen-masking systems to help frame the projected image and improve picture contrast. These systems can be connected to output , at the rear of the projector (Fig. 11).

For rear projection the screen must be translucent. For front projection, we recommend the use of screens with low gain specifications (i.e. 1.3 to 2). The use of high gain screens should be avoided due to their limited viewing angle, which is undesirable for a large audience. Preferably, use a screen with black, non-reflecting borders, which will perfectly frame the projected image. Avoid light shining directly on the screen during projection as this will reduce contrast and black level detail on the projected image. For the true cinema experience best results are achieved with little or no ambient light. Furniture and other objects with reflecting surfaces, as well as light coloured walls should be avoided, as they are likely to interfere with the screen's characteristics.

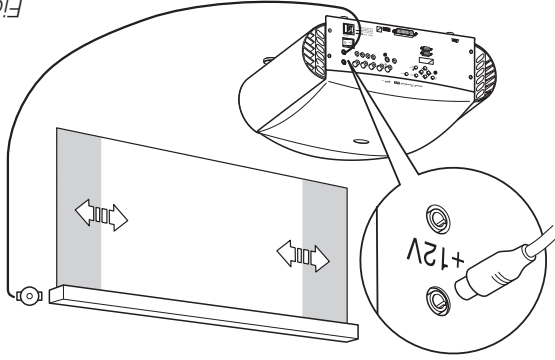

Fig. 11

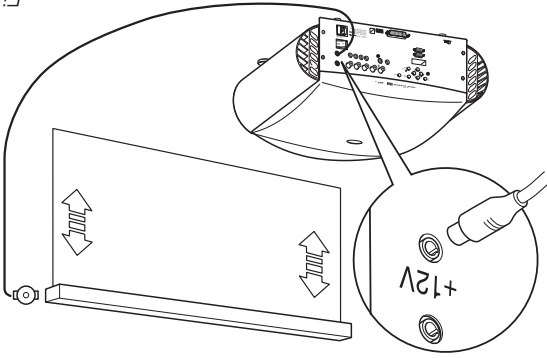

Fig. 10

5 SWITCHING ON AND OFF THE PROJECTOR

CAUTION: Connect the projector to a power supply with a nominal voltage within the following values: 100-240 Vac, 50/60 Hz. It must be earthed (Fig. 12).

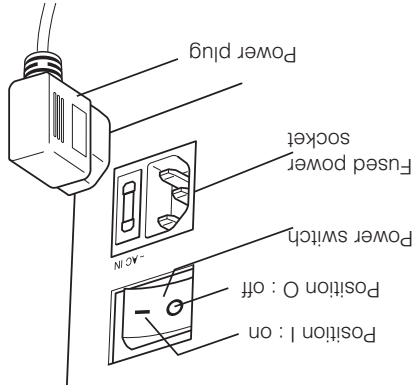

Fig. 12

Upon switch on (in position I) the projector will initialise (red and green LEDs on).

Followed by stand-by mode (red LED on) (Fig. 13).

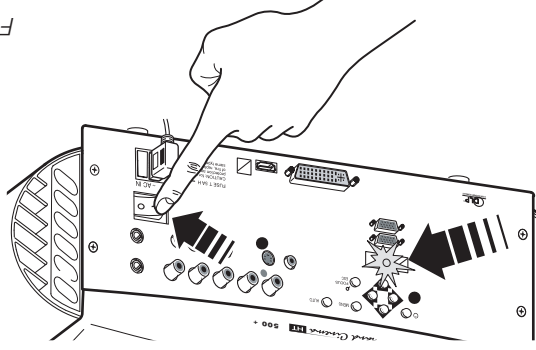

Fig. 13

SWITCH ON FROM STAND-BY

By remote control: press one of 1...9
By keyboard: press **Up** or **Down Arrow**.

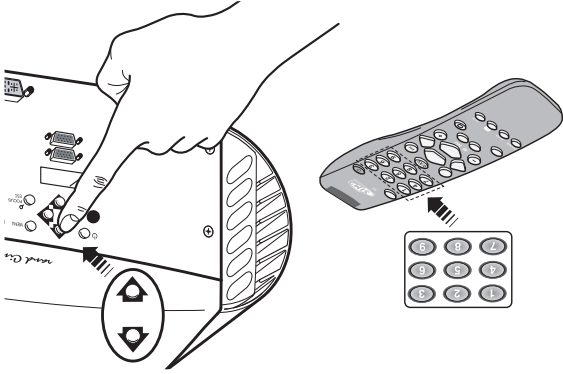



Fig. 14

When switching on from stand-by, the projector will turn on the lamp; after a brief warm up period the image will be displayed (green LED on). The input automatically selected will be the last one memorised prior to switch off (Fig. 14).
You may experience difficulties switching on the projector shortly after switching off: the lamp may fail to come on as it is too hot. Just wait a few minutes to cool it down.

SWITCHING OFF AND RETURNING TO STAND-BY

By remote control: press 
 By keyboard: press key 

When switching off, the projector goes in to stand-by memory-
 sing the input selection at the time of switch-off.
 The fans will continue to work until the lamp has cooled down

(red and green LEDs flashing) and will stop automatically after
 this period.

LED INDICATORS

The LED indicators, located in the top-rear of the projector,
 provide information about the state of the projector (see table
 below).

STATE	INDICATORS		NOTES
	GREEN	RED	
POWER OFF	OFF	OFF	The Power is turned off
INITIALIZATION	ON	ON	Power button has been pressed and the software is initialized (15 s)
STANDBY	OFF	ON	Projector is in standby mode
OPERATING	ON	OFF	Projector is on
COOLING LAMP	FLASHING	FLASHING	Projector is powering down; the fans are running to cool the lamp (1 min)
WARNING	FLASHING	OFF	Problems to display one or more source
ERROR	OFF	FLASHING	Internal circuit failure

6 CONNECTIONS

To obtain the best performance from your projector, we recom-
 mend the use of good quality "video cables" to the various
 signal sources (75 ohm Impedance).
 Poor quality cables will cause inferior picture performance.

For optimum connectivity we recommend you follow these
 simple steps:

- With exception of coaxial RCA/Phono type connectors,
 always double-check that the plug is inserted the correct
 way round to avoid damaging the plugs or the sockets on
 the projector (Fig. 15)

- Remove cables by the plug and do not pull on the cable
 itself.
- Avoid tangled cables.
- Position the cables carefully to avoid a trip hazard - espe-
 cially in low light areas.

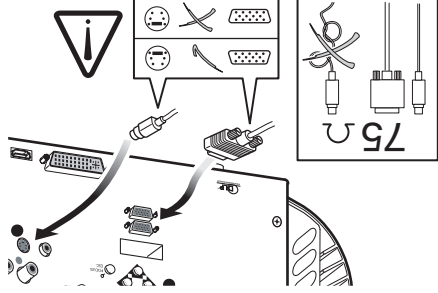

Fig. 15

Frequency of between 32-80 kHz and a Vertical frequency of between 48-100 Hz. Computer Resolutions of VGA, SVGA, XGA, SXGA and UXGA can be displayed.

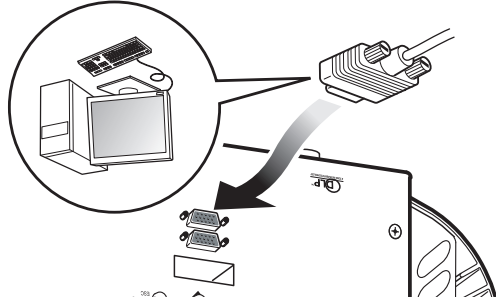

Fig. 18

RGB/CrCb INPUT

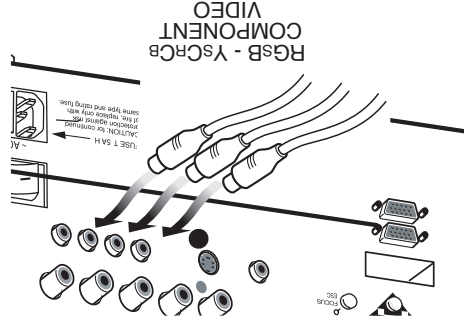

Fig. 19

This input is suitable for a RGB video signal, or for a Component (YCrCb) type, with composite synchronisation on the green signal (RGSB) or on the luminance (Y) signal (YsCrCb) through a cable with RCA/Phono or BNC type connector (Fig. 19).

RGB or YCrCb signals can also have H+V Composite Sync. In this case connect the R, G, B (or Y, Cr, Cb) outputs of the source to the respective R/Cr, G/Y, B/Cb inputs of the projector (paying attention not to invert the positions) and the synchronisation signal to the HV input. When connecting the three sets of RCA connectors use the colours as a guide: connector R is red, G is green, B is blue and HV is white. By using a suitable SCART to RCA connector adapter cable, an RGB video signal

COMPOSITE VIDEO INPUT

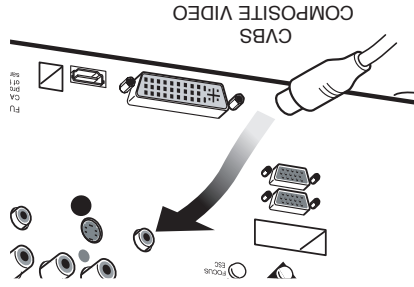

Fig. 16

This input is suitable for a "Composite Video CVBS" via a cable with an RCA/Phono connector (Fig. 16).

S-VIDEO INPUT

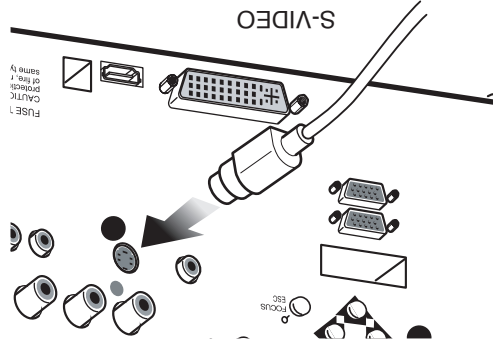

Fig. 17

This input is suitable for equipment fitted with a S-Video output to give improved picture performance (S-VIDEO/S-VHS) Connection is made via a 4-pin mini-DIN (Fig. 17).

VGA INPUT

Personal Computers, Video Processors (scalers) and Video Game consoles can be connected to the projector via the HDB

15-Pin (VGA) terminal.

Ensure the output of equipment connected is RGB with one of the following synchronisation options: separate H/V Sync, H+V Composite Sync (Fig. 18). This input accepts a Horizontal Scan

from a source equipped with an SCART connector can be connected to this input.

Component signals are connected to inputs Y, Cr and Cb, taking care to observe the correspondence with the outputs on the source. The video signals that can be connected to this input can have horizontal scanning frequencies of 15 kHz (standard video resolution), 32 kHz, or higher (progressive scanning video, high definition video).

Some sources provide the facility to choose between a progressive signal or an interlaced signal. Although in general it is often preferable to perform the deinterlacing operation on the projector rather than on the source because the projector is equipped with Faroudja's sophisticated directional correlation deinterlacing technology (DCD!™).

DVI™

This input allows you to advantage from the quality of the digital images.

If your source is equipped with a DVI-D output, YCrCb or RGB connect it to this input to exploit the quality of the HT500E system. (Fig. 20a).

HDMI™

With this input it is possible to integrate the optimal quality of a digital image with a multichannel audio signal.

The HDMI™ (High Definition Multimedia Interface) in fact integrates a multichannel audio signal with the uncompressed high definition video signal (Fig. 20b).

The interface also allows the exchange between the video source and the HT system of control data to optimise the quality of the projected image.

The HDMI™ input allows connection to video sources that use the HDCP (High-Bandwidth Digital Content Protection) protocol to protect their contents. This protocol is in fact incorporated in the definition of the HDMI™ technology.

Once the video source has been connected to the HDMI™ input, internal processing by the projector separates the video information from the audio information. This information is then available via an optical digital output with a female TO-SLINK connector in accordance with the S/PDIF standard.

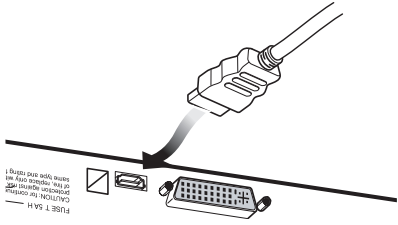

Fig. 20a

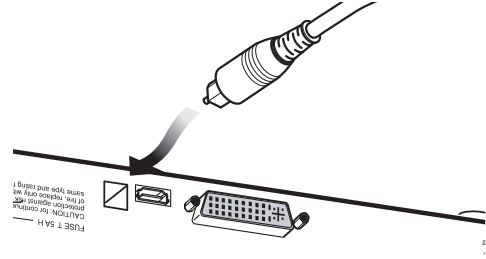

Fig. 20b

MOTORIZED PROJECTION SCREEN OUTPUT

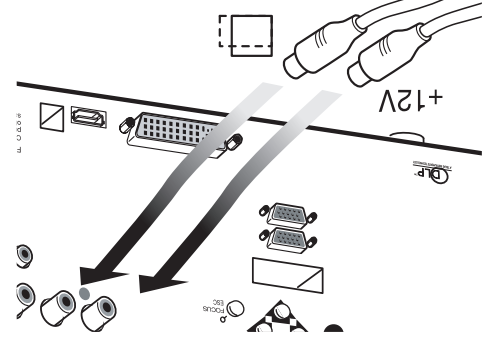



Fig. 21

The projector is equipped with two outputs (Voltage: 12 Vdc) for motorised projection screen and screen masking systems. The-12V outputs should be connected to the appropriate screen interface provided by the screen manufacturer (Fig. 21).

The +12V output is activated when the projector is switched on (green LED on) and is de-activated when the projector is in stand-by mode (red LED on). The output  can be used to control a screen masking system; its output can be set with the **Screen control adjustment** in the **Aspect** menu. This output allows reduction in the area of a 16:9 screen, into a 4:3 format, by activating a screen masking system (refer to screen manufacturer for further information).

RS232 INTERFACE CONNECTOR

It is possible to control the projector through a personal computer. First, load the appropriate projector control software onto your PC, then simply connect this input to a cable from your PC's RS232 serial port (Fig. 22).

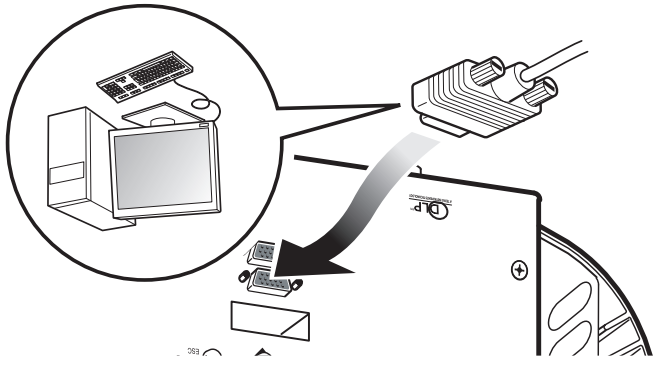
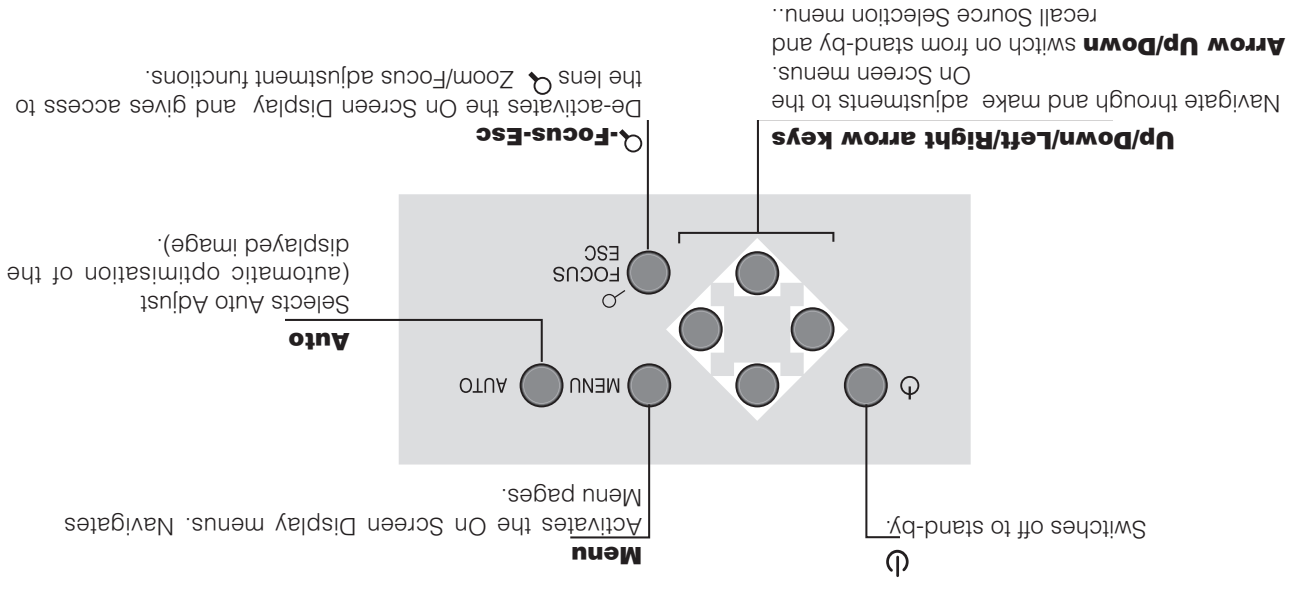

Fig. 22

7 KEYBOARD PAD

Eight push buttons, at the rear of the projector, will allow complete operation without the use of the remote control.



8 REMOTE CONTROL

Insert the batteries, taking care to match the polarity, as indicated in the battery recess of the remote (Fig. 23).

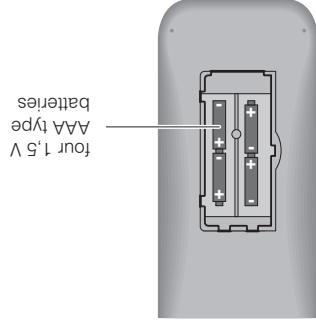

Fig. 23

Change the batteries in the remote control if experiencing difficulty in sending commands to the projector. If the remote control is not to be used for a long period of time remove the batteries. Replace all batteries at the same time; do not replace one new battery with a used battery. If the batteries have leaked, carefully wipe the case clean and replace with new batteries.

The remote control sends commands to the projector via infrared signals. It is possible to control the projector by pointing the remote control at the screen; the sensor at the front of the projector will pick up the reflected infrared commands. (Fig. 24).

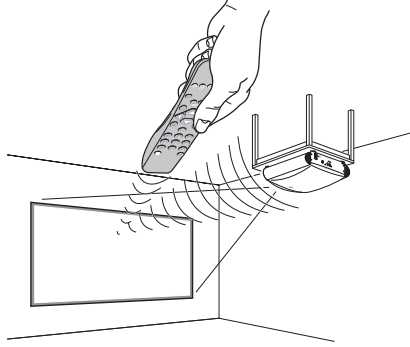

Fig. 24
Avoid placing obstructions between the remote control and the infrared sensor at the front of the projector; this will impair the remote control performance.

9 ON SCREEN MENU

All system functions can be activated from the keypad or remote control with the aid of a practical and comprehensive system of on screen menus.

INPUTS

The input selection menu (Inputs) is called by pressing 0 on the remote control and, when no other menu is displayed, using the \uparrow and \downarrow keys on the keypad. To select an input, scroll the list with the \uparrow and \downarrow keys until the desired input is highlighted, then press \rightarrow .

Display of the input selection menu is terminated by pressing the ESC key, or when the time allowed for displaying the on-screen menu has lapsed (set in the Set-up Menu).

Input 5 can accept RGB and YCrCb signals with a scan frequency up to 32kHz.

Inputs can receive RGB and YCrCb signals, at 15 kHz, 32 kHz or higher. The association between the input and the type of signal (RGB or YCrCb) is made from the pull-down menu that

appears on the right of the < symbol after pressing the \leftarrow key (Fig. 25b).

Input	Signal Type
1	VIDEO 1
2	S-VIDEO 2
3	COMP/RGB 3
4	COMP/RGB 4
5	GRAPH RGB 5
6	DVI-D 6
7	HDMI 7

Input 4 pull-down menu:

RGB 15KHz
YCrCb
YCrCb 32kHz

Fig. 25a

Input	Signal Type
1	VIDEO 1
2	S-VIDEO 2
3	COMP/RGB 3
4	COMP/RGB 4
5	GRAPH RGB 5
6	DVI-D 6
7	HDMI 7

Input 4 pull-down menu:

YCrCb AutoSync
YCrCb 15KHz
YCrCb
RGB Auto Sync
RGB 15KHz
RGB

Fig. 25b

In the pull-down menu it is also possible to choose the horizontal frequency or use the AutoSync feature; in this case the system detect the horizontal frequency signal (15kHz, 32kHz or higher) automatically.

Input is capable of receiving YCrCb or RGB signals coming from DVI-D sources.

The selection should be made from the drop menu following the indications described above.

After selecting the source signal (by means of the \downarrow and \uparrow keys), press MENU+/MENU- to confirm and close the pull-down menu; the value you have just set will be displayed on the right of the > symbol.

As with the other inputs, you can now select the input just set by pressing the \rightarrow key.

During the short time it takes to find the signal, a box appears showing the signal requested. As soon as the signal is shown in the box additional information is displayed concerning the video standard (for video signals) or resolution (for graphic signals), and format.

From the SETUP menu it is possible to choose to visualize or not this information, for more details check the *SOURCE INFORMATION* in MENU section.

MAIN MENU

To access the main menu of the On Screen Display press the MENU key on the keypad or the MENU+ or MENU- key on the remote control.

The main menu is divided into four windows, PICTURE, IMAGE, SETUP and MENU, in which the various adjustments are grouped according to the frequency of use. Use \downarrow and \uparrow to select the line corresponding to the adjustment you wish to make (Fig. 26).

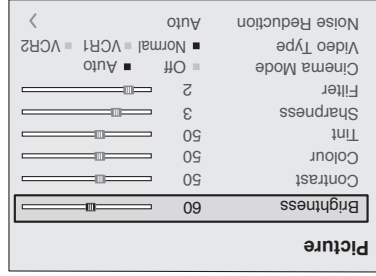

Fig. 26

The various menus only offer the relevant adjustments in accordance with the type of input signal displayed (e.g. certain typical adjustments for video signals, not necessarily for graphic signals, do not appear on the menus, and vice versa). Some adjustments (e.g. BRIGHTNESS and CONTRAST) are associated with a numerical value that can be varied within the set limits using the keys \rightarrow / \leftarrow . For others (e.g. VIDEO TYPE) you can choose among three options presented on the same \rightarrow / \leftarrow).

Other adjustments (marked by the > symbol) provide submenus, which appear as a superimposed window in which the selection is made with the \downarrow and \uparrow keys (Fig. 27).

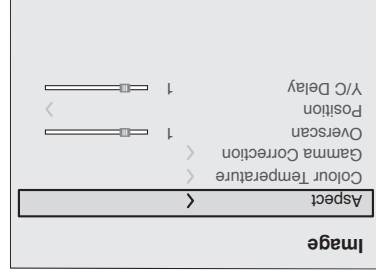

Fig. 27a

These submenus are accessed by pressing the \leftarrow key, while Press ESC on the remote control or keypad to interrupt the menu display or wait for it to disappear automatically after the number of seconds set on the SETUP page.

PICTURE

This menu features the adjustments related to picture quality. Adjustments that are not available for a given input do not appear on the menu. Table 4 summarises the adjustments available for each input. For a complete overview of the on-screen menus, consult the *ON SCREEN MENU LAYOUT* in the *ADDITIONAL INFORMATION* section.

BRIGHTNESS

Use this control to adjust the image's black level without affecting white areas. Increasing the value will give more detail in darker parts of the picture. For correct adjustment it may prove useful to display the signal relative to the grey scale within which the black level and the level immediately above it must be separately identifiable. Alternatively use a scene composed of black objects alongside other dark coloured objects.

CONTRAST

Use this control to adjust the image's black level without affecting white areas. To ensure correct adjustment, it may prove useful to display the signal relative to the grey scale, within which the white level and the level immediately below it must be separately identifiable. Alternatively use a scene composed of well-lit white objects surrounded by light coloured objects with lower level lighting.

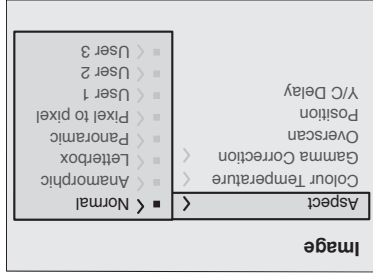

Fig. 27b

VIDEO TYPE
Activates a filter to improve stability of pictures from video recorders or DVD players. To toggle between NORMAL, VCR1 mode and VCR2 mode press **●** on the remote control.

NOISE REDUCTION
This adjustments allows to choose the filter value for noise reduction purposes. As soon as this option is selected on the menu, the image is divided in two parts. In the left side the image is not altered by the filter, in the right part the filter is activated. This allows you to compare the effect of the filter. It is possible to deactivate the filter (NOT ACTIVE), to use the automatic adjustments (AUTO) or to manually select (MANUAL) the value suitable for the image with the VALUE adjustment. In case of using the VALUE adjustment, it is enough to select to cursor below and set the value with the **← / →** keys of the remote control.

Associated to the NOISE REDUCTION there is the possibility to use the specific function (FLESH TONE CORRECTION) to make skin tone more natural. Often the use of noise reduction filter slightly degrades the image in those areas where skin tones are visible. With the use of this function it is possible to maintain an excellent image quality throughout the entire projected image.

Table 4

Inputs		Brightness	Contrast	Colour	Tint	Sharpness	Sharpness Mode	Filter	Cinema Mode	Video Type	Noise reduction	Flesh tone correction
DVI-D	RGB Grafico	●	●	●	○	●	●	●	●	●	●	●
HDMI™	Y/Cb	●	●	●	○	●	●	●	●	●	●	●
	RGBS	●	●	●	○	●	●	●	●	●	●	●
	RGBS 15KHz Y/Cb 15KHz	●	●	●	○	●	●	●	●	●	●	●
	Video S-Video	●	●	●	○	●	●	●	●	●	●	●

○ Present only if the Video Standard is NTSC

COLOR

This control (also called Saturation) increases or decreases the picture colour intensity. When set to zero, colour images will be shown in black and white. Increasing the value, try to find the point at which the colours look natural: suitable references include skin tones and grass in landscape shots.

TINT

Controls the purity of the colours. Basically determines the red-green ratio of the picture. Reducing the value will boost the red contents of the picture, increasing the value will boost the green tones. For this adjustment use skin tones or a test pattern image with colour bars as a reference.

SHARPNESS

Use this adjustment to increase and decrease the level of picture detail. When the sharpness value is reduced the image details appear less pronounced, while increasing the value raises image definition, making the outline of objects sharper. Note that an excessively high value may result in a 'noisy' picture and the edges of objects may be unnaturally defined.

SHARPNESS MODE

This allows you to select the type of processing associated with sharpness adjustment. In the case of a progressive or interlaced video signal VIDEO mode is advisable; with PC graphic signals use GRAPHIC MODE.

FILTER

This allows you to select the mode in which the input signal is processed. Selecting the most appropriate value for a given input signal ensures the best horizontal and vertical definition and makes the picture sharper.

CINEMA MODE

In AUTO the deinterlacer recognises if the video signal source is a movie film (obtained from a Telecine device with 3:2 or 2:2 pull-down) and applies a deinterlace algorithm optimised for this type of signal. If the video source is not identified as a film, or if you select NO the deinterlacer applies a Motion compensated algorithm optimised for video camera signals.

IMAGE

This menu features adjustments relating to picture position, aspect ratio, etc.

ASPECT

This adjustment allows you to change the dimensions and aspect ratio (relationship between width and height) of the displayed image. There are five preset aspects available and three personalised aspects (with user-settable parameters). You can select a different aspect for each source: the selected aspect ratio will be automatically called the next time the relative source is called.

You can also select the required aspect ratio by repeatedly pressing the **▶** key, or by pressing **▶** and a numerical key (1..8).

The following aspects are available.

NORMAL: projects the image occupying the full height of the screen while maintaining the aspect ratio of the input signal. When the input signal aspect ratio is 4:3 black vertical bands are displayed on the right and left of the picture.

ANAMORPHIC: allows a 16:9 picture to be displayed correctly.

LETTERBOX: serves to display 4:3 letterbox image (with source signal having black bands above and below the picture) so that it fills the 16:9 screen and maintains the correct aspect ratio.

PANORAMIC: this aspect stretches the 4:3 image, slightly cropping the upper and lower parts.

Panoramic is ideal for displaying a 4:3 image on the 16:9 screen of the Display.

PIXEL TO PIXEL: this aspect displays the image as it is input without adapting it to the screen.

The image is projected in the centre of the screen and if its horizontal and/or vertical dimensions are smaller than the display, it is bounded by vertical and/or horizontal black bands.

USER 1, 2, 3: When none of the preset formulas are suitable, the User formulas are available, with the facility for continuous horizontal and vertical adjustment of picture size.

SCREEN CONTROL

If an appropriate screen-masking interface is connected to the 12V output socket it is possible, for each aspect, to re-

frame the screen to a variety of aspect ratios and screen sizes (please refer to the screen manufacturer's manual).

COLOR TEMPERATURE

The color temperature adjustment is made by positioning the white point inside CIE chromaticity diagram.

The systems allows to choose from 36 predefined white points inside the neutral color area (Fig.28).

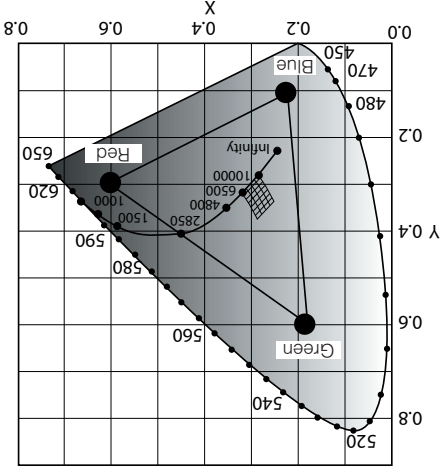

Fig. 28

The correlated color temperature varies along horizontal lines, low temperatures are present in the right side (where the red component is increased), in the left side of the diagram you can find high temperature values (in which blue component is higher). The points along the lower horizontal line (Fig.29) represent colors that belong to the black body curve.

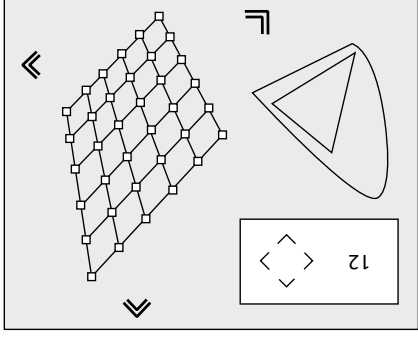

Fig. 29

Tips to assist in setting up this parameter are provided in Table 5

Standard Gamma function	Enhanced SIM2 Gamma function	Graphics Gamma function
ST1 For generic uses.	EN1 Suitable for displaying images from sources such as video cameras, digital cameras or TV studios in high ambient light conditions.	G1 Suitable for displaying graphic images (e.g. Windows Desktop) in medium ambient light conditions.
EN2 Suitable for displaying images from sources such as video cameras, digital cameras or TV studios in low ambient light conditions.	EN3 Suitable for displaying movie films in high ambient light conditions.	G2 Suitable for displaying graphic images in controlled ambient light conditions.
EN4 Suitable for displaying movie films in medium ambient light conditions.	EN5 Suitable for displaying movie films in controlled ambient light conditions.	

Along vertical lines the color temperature is constant but is different from black body curve, which mean if you select point from the high part of the diagram you increase the green component, while low part of diagram cause an increase of purple component.

GAMMA CORRECTION

Determines the system's response to the grey scale, emphasizing or attenuating the different grades of brightness (blacks, dark, medium, light grey, whites) in the projected image. The projector is equipped with several gamma functions, allowing the best display of any image in relation to the video source type, ambient light conditions, and the personal preferences of the viewer.

The system provides 4 groups of gamma curves: Standard (ST), Enhanced SIM2 (EN), Graphics (GR), and Personal. The Standard curve is suitable for generic use: this curve is well adapted to displaying images from video cameras, digital cameras, and films or photos from personal computers. The Enhanced group is suitable for viewing movie films. The Graphics group is suitable for displaying simple graphic images (desktop PC, CAD, PC presentations,...). The Personal setting allows the gamma curve to be defined parametrically. The user can select the coefficient that determines the shape of the curve. Coefficient values between 1.5 and 2.2 serve to emphasize details in darker parts of the picture although the global perception of contrast is reduced. Values higher than 2.2 increase the global perception of contrast while attenuating the visibility of details in darker areas of the picture. With the most common video sources a parameter value of 2.2 will give high quality pictures with the right amount of contrast.

OVERSCAN

Remove noise around image. Some sources can produce a picture with noise along edges, thanks to the overscan function it is possible to drop such imperfections outside the projected area. The overscan value can be included between 0 (no overscan) and 32 (maximum value). The image maintains in any case the aspect.

POSITION

Use this adjustment to position the image vertically and horizontally. Determines the aspect ratio of the projected image. These parameters do not normally require adjustment because the system checks the input signal and automatically sets the most suitable values.

However, if the image is not perfectly centralised it may prove useful to request the system to repeat the input signal analysis and image positioning, calling the automatic control procedure from the A/TO button on the remote control or keypad. When this procedure is called it is helpful to have a white or light coloured background on the screen in the current picture.

FREQUENCY/PHASE

These adjustments, available for progressive signals and for signals from PC, ensure correspondence between the number of pixels making up the signal and the number of pixels making up the projected image.

These parameters do not normally require adjustment because the system checks the input signal and automatically sets the most suitable values.

However, if the image appears disturbed (loss of position within the equidistant vertical bands or instability and lack of sharpness on the narrow vertical lines) it may help to prompt the system to repeat the input signal analysis and determination of the best parameters by calling the automatic adjustment procedure with the A/TO key on the remote control or on the keypad.

If the automatic procedure fails to have the required effect, enter the frequency and phase values manually and approach the screen sufficiently to observe the effects of the adjustments.

Y / C DELAY

In the case of Video and S-Video signals, it may be necessary to correct horizontal colour misalignment within the projected image. For a given video standard (e.g. PAL or NTSC) the stored value does not normally require further fine-tuning, unless the source or connection cable has changed.

Table 6

Inputs	Adjustments						
	Position	Aspect	Frequency	Phase	Colour Temperature	Gamma Correction	Overscan
Video S-Video	•	•	-	-	•	•	•
RGBS 15KHz YC/Cb 15KHz	•	•	-	•	•	•	•
RGBS	•	•	•	•	•	•	•
Y/Cb	•	•	•	•	•	•	•
RGB Grafico	•	•	•	•	•	•	•
DVI-D HDMI™	-	•	-	-	•	•	•
	Y/C Delay						

SETUP

The setup menu contains less frequently used adjustments that may be required during installation (e.g. *On Screen Display* language selection or the display of Test Patterns).

ORIENTATION

Select the option that best describes the installation i.e. desktop front, ceiling front, desktop rear and ceiling rear.

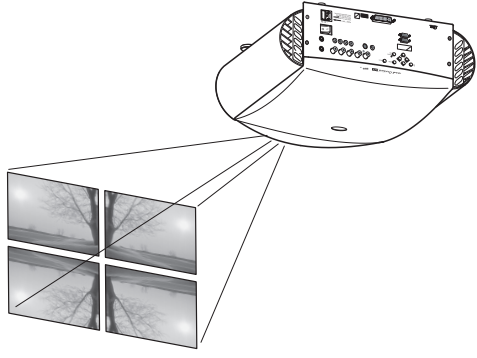

Fig. 30

The keystone adjustment helps to compensate possible horizontal tilts of the projector.

LENS

The ZOOM adjustment impacts on the motorized zoom lens allowing to increase or decrease the dimension of the projected image. The FOCUS adjustment impacts on the motorized lens focus, allowing to obtain the highest definition on the projected image, an accurate focus setting should allow the viewer to distinguish each pixel that create the image one from another. In association with the ZOOM, FOCUS and LENS SHIFT adjustments the HT500E system provides three test patterns to be used if there is no suitable signal available to set up these parameters.

This test pattern is displayed by pressing the ● key, once the right adjustments are reached using the → and ← keys, the test image can be easily removed pressing again the ● key of the remote control. The LENS SHIFT adjustment allows to move horizontally (keys → and ←) and vertically (keys ↓ and ↑) the lens, in order to center the image.

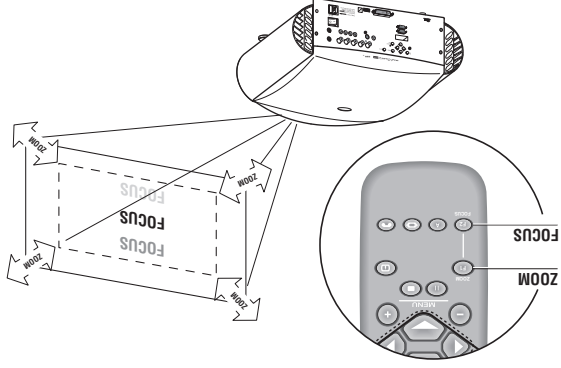

Fig. 33

In the initial phase of installation the configurable keys (F1, F2) serve as optical zoom and optical focus (Fig.33).

LAMP POWER

If your room is especially dark, the images from the system HT500E could result excessively bright. In order to enjoy wonderful images, the ECOMODE function allows to reduce the power used to feed the lamp. In this way, the brightness of the image will be adapted to your projection conditions and a greater life lamp will be guaranteed.

HORIZONTAL/VERTICAL KEYSTONE
To obtain maximum quality of the projected image, we recommend the installation of the projector on a level platform parallel and central to the screen.
Adjust the feet underneath to obtain a level position, lining up the base of the projected image to the base of the projection screen (Fig. 31).

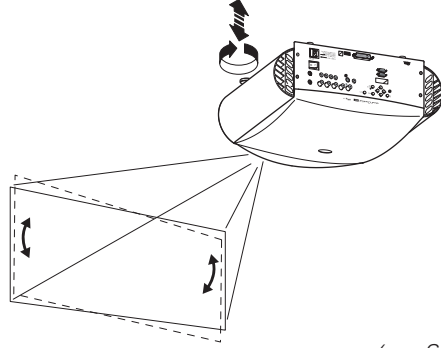

Fig. 31

If the projected images needs to be centered, the LENS SHIFT (see next paragraph) adjustment allows the projected image to be moved vertically and horizontally, in relation to the centre of the screen (Fig. 32).

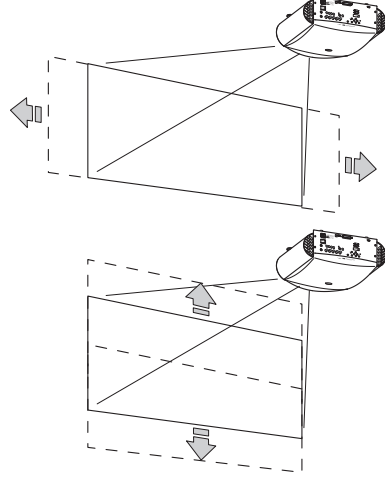

Fig. 32

In the event you are unable to centre the image within the screen area, tilt the projector until the image is correctly positioned. Any keystone error can be removed by the Keystone adjustment in the Set up menu.

POWER ON

If active (AUTO) allows to power up the system directly from the power feeder, once the initializing phase is completed. If not active (STAND-BY) once the initializing phase is completed the system remains in a stand-by mode waiting to receive the power on command from the remote control or the key pad.

TEST PATTERNS

Displays a series of five test patterns, useful for the installation of the projector.
Press \downarrow and \uparrow keys to browse pattern.

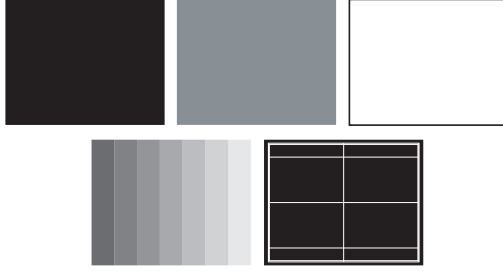

FACTORY DEFAULTS

Reconfigures the projector to original factory settings except Position, Orientation, Y/C Delay, Zoom and Focus.



MENU

LANGUAGE

Lists the languages available for the *On Screen Display* menus.

SOURCE LIST

In order for the HT500E system to be more flexible, the following described functions allow to modify the input selection menu making it more user friendly.

The main window shows all the inputs available on the Projector. If one or more inputs are not utilized, it is often helpful to blank them from the input list (accessed with the 0 key). Once the input has been chosen, in the drop menu that appears by pressing the \rightarrow key, it is possible to activate the source (Fig. 34). The exclusion or activation of the source will automatically renumber the remaining active inputs.

Fig. 34

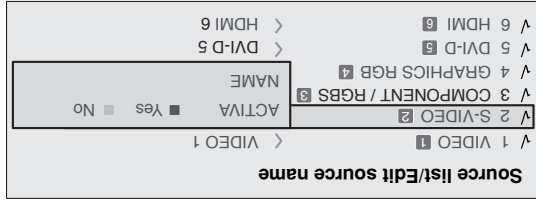

The inputs with an active video signal (visible in the input selection menu) are marked with a check symbol. It can be also helpful to identify the input with a name chosen by the user (for example with the name of the connected source) rather than with the signal type. Once chosen to have the input visible, in the drop menu, by selecting the Name option it is possible to rename the source in use. This will make it easier to remember the source connected to a specific input. You can use up to 12 alphanumeric letters to name the source (for more details check the "Insert text" section)

Insert text

You will be able to insert text easily and rapidly by accessing the text insertion menu (fig. 35).

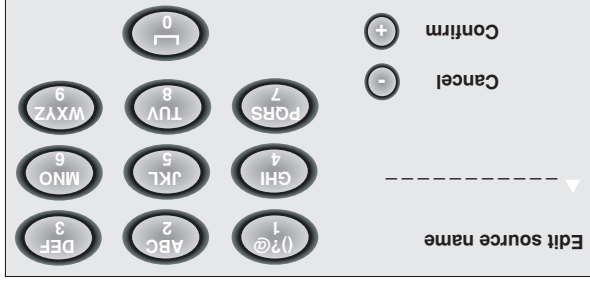

Fig. 35

The text insertion mode remains the same if text is being inserted for the first time or if a previously inserted name is being edited. The letter insertion can be done in any available position (represented by horizontal lines).

Magnification
 Allows you to select the area to be viewed and then magnify the projected image. The degree of enlargement is selected in Zoom mode (identified by a magnifying glass in the centre of the image) using the ← and → keys. The area of the picture to be enlarged is selected in Pan mode (symbol in the centre of the picture) using the ←, →, ↑ and ↓ arrow keys. You can toggle between Zoom and Pan mode by pressing the F1/F2 key on the remote control.

Blank
 Blanks the active video signal producing a completely black screen. Once pressed the key an indication of a few seconds on the OSD will confirm its activation. A click of any other key of the remote control allows to restore the previous settings.

Color temperature
 The following click of the key (F1 or F2) allows to choose between the different color temperatures available: HIGH, MID, LOW, USER.

Gamma correction
 The following click of the key (F1 or F2) allows to choose between the different gamma curves available.

SOURCE INFORMATION

When active (YES) each source change will show the information related to the signal. If not active (NO) there will be no information on the selected source.

OSD BACKGROUND

Determines the type of background for the On Screen Display.

OSD TIMEOUT

Use this adjustment to set the display time after which the On Screen Display will disappear.

OSD POSITION

Allows the On Screen Display to be positioned in a particular area of the projected image. The OSD can be positioned using the arrow keys for fine adjustments or keys 1...9 on the remote control to select one of 9 preset positions.

Use the ← and → keys to move between letters either left or right respectively.

Press the numeric key matching the letter (Fig. 35), the first click of the key selects the first letter, the second click the second letter and so on.

The available letters are shown in the text insertion menu. Once one letter has been inserted, to insert the following one it is necessary to move with the cursor in the next right position with the → key of the remote control, repeat this procedure to insert other letters.

Use the ↓ key to switch from small case to capital letters and viceversa. Any mistake can be deleted with the ↑ key once it has been positioned on the wrong letter.

Once the text insertion process is finished, it can be confirmed and saved by clicking the MENU+ key. If you want to delete the modifications use the MENU- key of the remote control.

F1/F2 KEYS

This allows to assign different functions to the remote control keys, named F1 and F2.

The window is made of 6 options, once for each line and by two columns showing the F1-F2 keys. The choice between F1 and F2 is made by the ← and → keys of the remote control; the function given to F1 and F2 is chosen with the ↑ and ↓ keys. The function delivered by the key is memorized by the interaction on the line and column. In the following window are described the 6 options

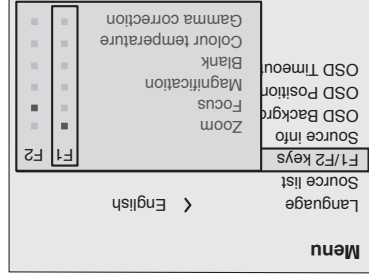

Fig.36

Zoom

Allows to access the optic zoom, where the ← and → keys allow to increase or decrease the size of the projected image.

MEMORIES



The main parameters of the image may be saved in distinct groups of values (known as 'Memories'); these parameters can subsequently be applied all together by way of a single command.

There are 3 distinct Memories (Memory 1, Memory 2, Memory 3) for each of the 25 signal types managed:

1	VIDEO	
2	S-VIDEO	
3	COMP/RGB(YCrcb 15kHz)	3 COMP/RGB(RGB 15kHz)
3	COMP/RGB(YCrcb 32kHz)	3 COMP/RGB(RGB 32kHz)
4	COMP/RGB(YCrcb 15kHz)	4 COMP/RGB(RGB 15kHz)
4	COMP/RGB(YCrcb 32kHz)	4 COMP/RGB(RGB 32kHz)
5	GRAPHICS RGB	
6	DVI-D (RGB)	
6	DVI-D (YCrCb)	
7	HDMI	

making a total of 75 different available Memories. The image parameters that can be saved/recalled by the Memories management system are the following:

Image	BRIGHTNESS
	CONTRAST
	COLOR
	TINT
	SHARPNESS
	FILTER
	SHARPNESS MODE
	VIDEO TYPE
	NOISE REDUCTION
Setup	LAMP POWER
Picture	ASPECT
	COLOR TEMP.
	OVERSCAN
	GAMMA

Some of these parameters may not be available for certain inputs or certain input signals, as indicated in Tables 4 and 5. The menu page for the Memories management functions is activated by pressing the  key on the remote control or the  key on the keypad (Fig. 37).

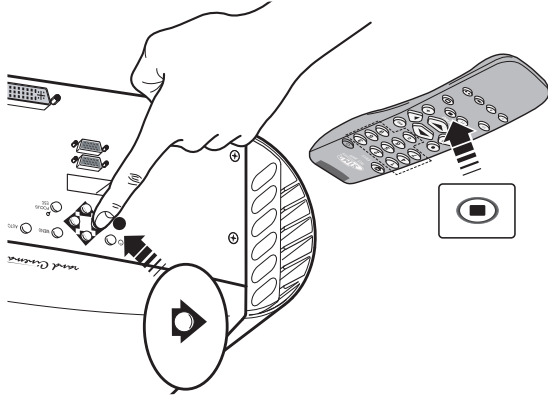





Fig. 37

The operations that can be performed on each memory selected are described here below.

Save a memory

To save the current values of the image parameters in Memory 1, use the  and  keys to move to line '1' and then open the pull-down menu by pressing the  key (Fig. 38). Then select the option 'Save current settings'. To confirm that the operation has been completed successfully, the message *Current settings saved in Memory 1* is displayed at the bottom of the screen and the letter 'S' appears to the left of the memory name. The same procedure is used to save parameters in Memories 2 and 3.

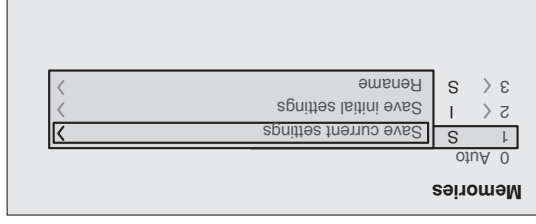



Fig. 38

Recall a memory

To recall a Memory, select the desired line and press . The parameters saved in the selected Memory will be applied to the image displayed and a message will appear to confirm

QUICK MENUS

The quick menus provide access to the main adjustments that affect image quality, without calling the main On Screen menus.

BRIGHTNESS, CONTRAST, COLOUR, TINT, SHARPNESS and FILTER adjustments appear at the bottom of the screen one after the other when the \downarrow and keys are pressed \downarrow .

MESSAGES

The following messages may appear during operation of the system:

No signal

The system does not recognise any signal applied to the selected input. In this case:

- Make sure the selected input is connected to a video or graphic signal and that that source is functioning correctly.
- Check the condition of the cables used to connect the system to the various sources.
- Make sure the video or graphic signals supplied by the source are compatible with the system's technical specifications and, in particular, with those of the selected input.

Out of Range

This message appears when either the resolution or the vertical/horizontal frequency of the input signal exceeds system specifications (e.g. a QXGA graphic signal) or when an input is supplied with an incompatible signal (after setting the components input to YCrCb 15kHz a progressive signal is connected).

Substitution lamp

If the lamp hours exceed the 90% of the life lamp, at every switching on, a brief message appears on the screen to re-member the need of replacing it in a short time.

If the lamp life is greater than 100% the message above persists until the ESC key is pressed.

the operation *Memory 1 recalled*. The Memory recalled will be associated with the source and signal type, and will be automatically recalled every time that particular source and signal type combination is selected.

Save default settings

To restore the original values to a previously modified Memory, select the line corresponding to the Memory in question and open the pull-down menu (\rightarrow key). Then select the line *Initial settings saved in Memory 1*. To confirm that the operation has been completed successfully, the message *Memory 1 initialised* is displayed at the bottom of the screen and the letter 'I' appears to the left of the name of the memory.

Rename a memory

It is possible to assign a name to each Memory. To assign a name (with a maximum length of 12 alphanumeric characters) to a Memory, select the option 'Rename' from the corresponding pull-down menu. Enter the text following the procedure indicated in paragraph *SOURCE LIST*.

Restore Current Settings

On entering the MEMORIES menu, a copy of the current settings is saved in a temporary menu (labelled with 0 - AUTO). Once one or more memories have been recalled, you can restore the settings that were effective at the moment the Memories menu was accessed by selecting 0 - AUTO. However, this operation must be completed before the MEMORIES menu page disappears (30 seconds after the last operation commanded from the remote control or the keypad). The next time it appears, the temporary memory will contain new information that takes into account any Memories selected the penultimate time the 'Memories' page was accessed.

Memory 0 (- AUTO) can be used even when you do not wish to enable the Memories management function for the signal source is chosen, the settings that were effective at the time the Memory was previously recalled will be automatically applied.

INFO

Displays the current status of the projector and information concerning the projected video/graphic signal. This function is displayed on pressing **I** on the remote control (or, in the absence of the *On Screen Display*, the \rightarrow key on the remote control).

10 CLEANING AND MAINTENANCE

The Projector do not require internal cleaning.

There is no user serviceable parts inside the projector.

Please refer all service requirements to qualified personnel.

Cleaning the projector's cover:

Use a soft slightly damp cloth. Do not use abrasive cleaners, solvents or other harsh chemicals, as this will damage the finish of the cover. Avoid direct cleaning of the rear panel's screen-printing.

11 TROUBLESHOOTING GUIDE

No power (Green and red LED are OFF)

- Check the power switch at the rear: it must be in position I.
- Check if the power cable has been connected correctly to a working socket.
- Check the power socket fuse, at the rear of the projector.
- Replace the fuse on the mains socket with an identical type (T 5A H) (Fig. 2).

- Should the problem persist, seek authorised technical assistance.

The lamp is not coming on

- Allow a few minutes pause between switching off and turning on again (from stand-by). This will allow the lamp to cool down sufficiently.
- If the lamp doesn't come on – even though the projector has had sufficient time to cool down – seek technical assistance from your nearest Dealer.

No image

- Check that the selected input is actually connected to a active video or graphic signal.
- Check that the above source actually works.
- Verify compatibility of video/graphic signals with the technical specifications of the projector.

Image is disturbed, unstable or noisy

- Check the integrity of cables used to connect various sources.
- Check the cooling air inlets or air outlets on the units are not obstructed and the room temperature is below 35°C (95°F).

- Verify compatibility of video/graphic signals with the technical specifications of the projector.
- Check the integrity of cables connecting projector to various sources.

- If the signal source is a terrestrial broadcast (via a VCR) check that the receiving channel has been correctly tuned in and that the aerial system is in good working order.
- Should the problem be present with a signal coming from a video-reorder, ensure that the videotape is an Original "first generation" copy and in good condition.
- Adjust the VCR's tracking control for optimum picture performance. Ensure the VCR mode is active in the Picture menu.

Incomplete image along borders (vertical and horizontal)

- Compare compatibility of video/graphic signals and technical specifications of your projector.

- Adjust FREQUENCY and PHASE parameters, found in the IMAGE ADJUSTMENTS menu, to optimise vertical detail of the projected image.

Video image showing colour misalignment on vertical details

- Verify compatibility of video/graphic signals with technical specifications of your projector.
- Adjust Y/C DELAY settings in the IMAGE ADJUSTMENTS / ADVANCED SETTINGS to reduce colour misalignment. For best results use an external colour bar test pattern source.

Remote control does not work

- Check the batteries and for correct polarity.
- Ensure that the area between the infrared sensor (front of projector) and the remote control is free of obstruction.
- Ensure that infrared sensors (front and rear of projector) are not exposed to intense light levels.

- Press A on your remote control or AUTO on keypad to execute automatic adjustments.
- Adjust the horizontal and vertical position of projected image by selecting POSITION on the IMAGE ADJUSTMENTS menu.
- Adjust the width and height of image, selecting ASPECT in the IMAGE ADJUSTMENTS menu.
- Adjust the Overscan value in the IMAGE/OVERSCAN menu.

Image too dark, too pale or unnaturally coloured

- Verify compatibility of video/graphic signals with technical specifications of your projector.
- Go to PICTURE menu, select and regulate any of the following, accordingly: CONTRAST, BRIGHTNESS, COLOR, and TINT.
- If necessary, reset the COLOR TEMPERATURE and GAMMA CORRECTION (found on the IMAGE ADJUSTMENTS / ADVANCED SETTINGS menu).

Graphic image with poor quality vertical detail

- Verify compatibility of video/graphic signals with technical specifications of your projector.
- Press A on your remote control or AUTO on keypad to execute automatic adjustments.

12 OPTIONAL ACCESSORIES

You can purchase the following optional accessories at your Dealer:

- Ceiling Bracket Kit.
- Type of lens

Up to six types of lenses are available to accommodate different throw distances and your specific installations. See *ADDITIONAL INFORMATION* for more details on throw distances and the dimensions of the image projected. To change the lens, contact always your nearest dealer.

CAUTION: for ceiling installation, by means of suspension bracket, carefully follow the instructions and safety instructions recommended by the Manufacturer in the bracket's literature.

Use only original, or SIM2 Multimedia approved, accessories.

13 ADDITIONAL INFORMATION

A TECHNICAL SPECIFICATION

PROJECTOR

OPTICA

Projection system:	triple panel DMD™ HD2+ FTP DarkChip2(1280x720 pixel)
Color Filter:	Dichroic Filter (50mmx50)
Contrast ratio:	4300:1 (lens L2)
Projection lens:	"zoom", focus, zoom, and horizontal/vertical shift motorized
Lamp:	250W
Lamp life time:	1500 hours (average value measured in the laboratory under optimal conditions; it can be sensibly reduced by the unit misusing)

Type Lens	Throw Ratio
L1	1.2—1.44
L2	1.44—1.8
L3	1.8—2.4
L4	2.4—3.6
L5	3.6—5.6

Projection distance (between the screen and the center of the lens)		Type Lens	Image width
1.6	1.9	L1	Min Max
1.9	2.4	L2	Min Max
2.4	3.1	L3	Min Max
3.1	4.2	L4	Min Max
4.7	4.7	L5	Min Max
1.3m (51")	1.7m (69")		
2.2m (86")	2.6m (96")		
3.3m (130")	4.0m (130")		
4.4m (175"m)	5.3m (175"m)		
5.5m (220"m)	6.4m (220"m)		
6.6m (260")	8.0m (260")		
7.8m (300")	9.5m (300")		
1.9	2.4		
2.5	3.1		
3.1	3.9		
4.8	6.0		
6.0	8.0		
8.0	10.0		
10.0	13.3		
11.9	15.9		
14.0	18.6		
3.1	4.2		
4.7	6.3		
7.8	9.8		
12.2	18.5		
18.5	24.8		
27.9	37.1		
4.7	7.3		
6.3	9.8		
7.8	12.2		
12.0	18.5		
15.9	24.8		
20.0	31.0		
23.8	37.1		
27.9	-		

<p>Control: Infrared remote control, RS232 serial (DB9 connector, female)</p> <p>Outputs: - 2 12-V jack connector outputs (1 active with system powered on, 1 active with 16:9 aspect ratio selected) - 1 Optical S/PDIF audio output Toslink connector</p>	<p>ELECTRICAL</p> <p>Input signals:</p> <ul style="list-style-type: none"> • 1 COMPOSITE VIDEO (CVBS) RCA type connectors, gold-plated 1,0 V_{pp} / 75 Ω, negative synchronisation • 1 S-VIDEO (Y/C) 4-pin mini-DIN connectors Y: 1,0 V_{pp} / 75 Ω, negative synchronisation C: 0,286 V_{pp} / 75 Ω, [NTSC nominal burst level] 0,3 V_{pp} / 75 Ω [PAL, SECAM nominal burst level] • 2 COMPONENTI (Y/Cr/Cb/H/V) - RGBHV 1 set of 5 RCA connectors, gold-plated 1 set of 5 BNC type connectors, gold-plated - Components signal Y: 1,0 V_{pp} / 75 Ω, negative or 3-level synchronisation Cr,Cb: 0,7 V_{pp} / 75 Ω - RGB signal R,B: 0,7 V_{pp} / 75 Ω G: 0,7 V_{pp} / 75 Ω, separate H/V Sync or H+V Sync 1,0 V_{pp} / 75 Ω, negative or 3-level synchronisation H,V: TTL positive or negative, 0,3-5 V_{pp} / 1 kΩ • 1 RGBHV (analogue RGB) female DB15HD connectors R,B: 0,7 V_{pp} / 75 Ω G: 0,7 V_{pp} / 75 Ω, separate H/V Sync or H+V Sync 1,0 V_{pp} / 75 Ω, negative or 3-level synchronisation H,V: positive or negative TTL, 0,3-5 V_{pp} / 1 kΩ • 1 DVI (digital RGB) DVI-D female connector • 1 HDMI™
<p>Control: Remote control, via RS232 from PC or home automation devices from 15 to 80 kHz (up to UXGA, 85 Hz) 48 - 100 Hz</p> <p>Horizontal frequency: automatically selected (PAL B, G, H, I, M, N, 60, SECAM, NTSC 3,58 and 4,43) ATSC HDTV (480p, 720p, 1080i), VGA, SVGA, XGA, SXGA, UXGA Deinterlacer:</p> <p>High definition video: Faroudja chipset, DCD™, 3:2 pull-down sequence conversion from 6500 to 10000 K</p>	<p>Colour temperature: from 6500 to 10000 K</p>
<p>Consumption: 340 W max T 5 A H, 5 x 20 mm Dimensions of projector: 540 x 210 x 615 mm (LxAXP) Weight of projector: 28 kg Operation temperature: 10 to 35°C Storage temperature: -15 to 55°C Humidity: 20% a 95% humidity non-condensing</p> <p>Safety: EN 60950</p> <p>Transportability: desktop equipment EN 55022 Class B EN 55024 EN 61000-3-2 EN 61000-3-3 IEC 68-2-31, IEC 68-2-32</p>	<p>Transportation:</p>
<p>Power supply cable: (EU, UK e US); length 2 m da 100 a 240 Vac, tolerance +/- 10%, frequency from 48 to 62 Hz</p>	<p>Compatibility:</p>

GENERAL PROJECTOR

unit: mm

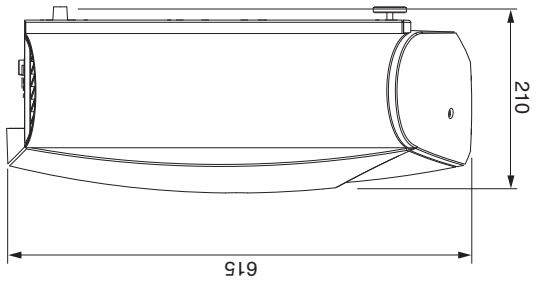
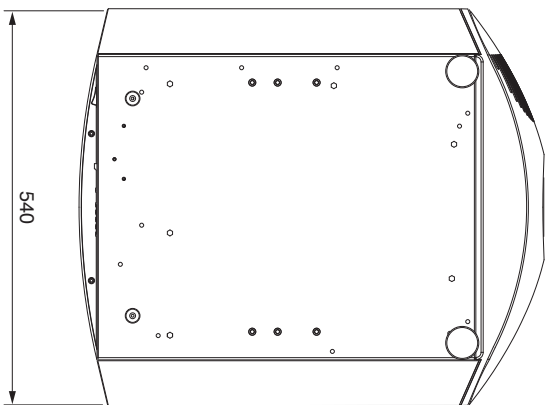

PROJECTOR

B DIMENSIONS

C ON SCREEN MENU LAYOUT

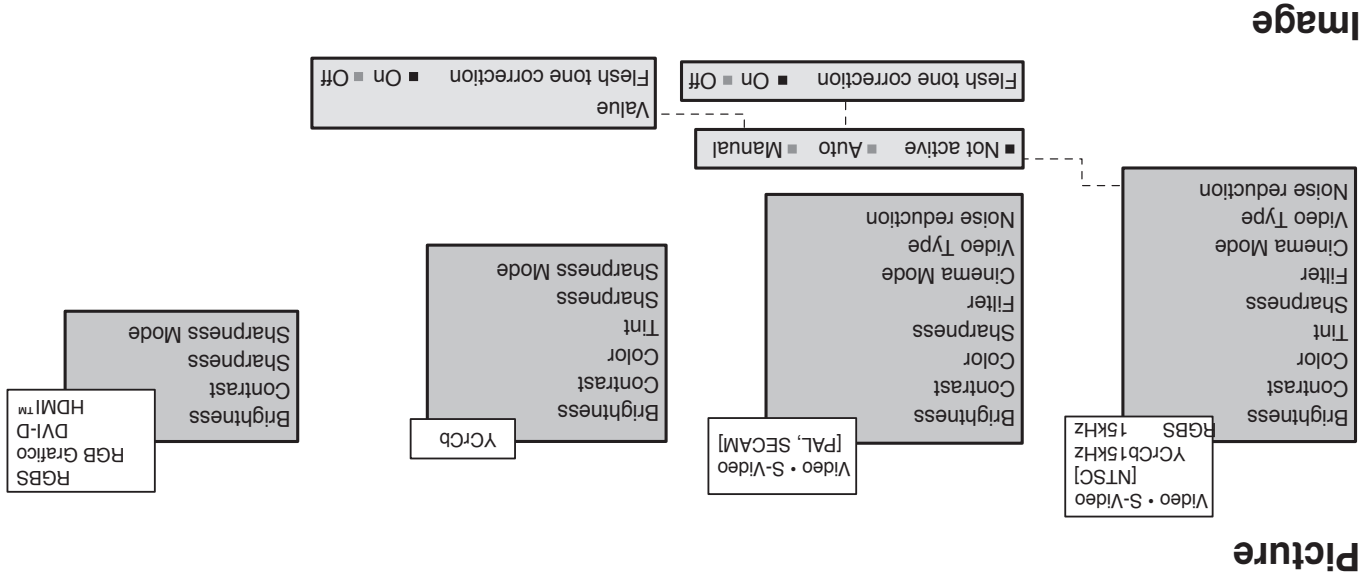

Picture

Image

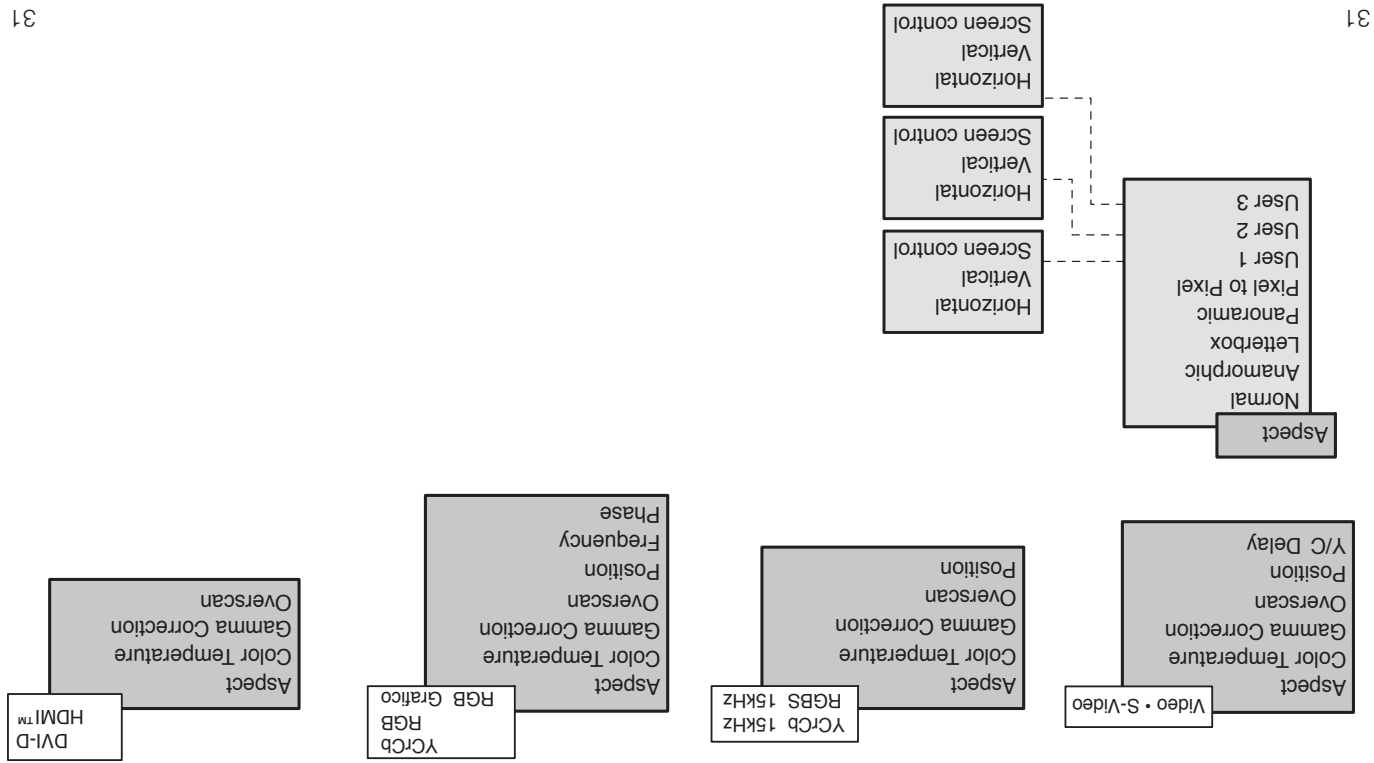

Setup

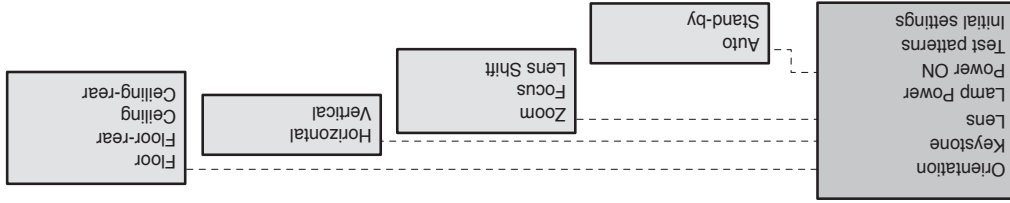

Menu

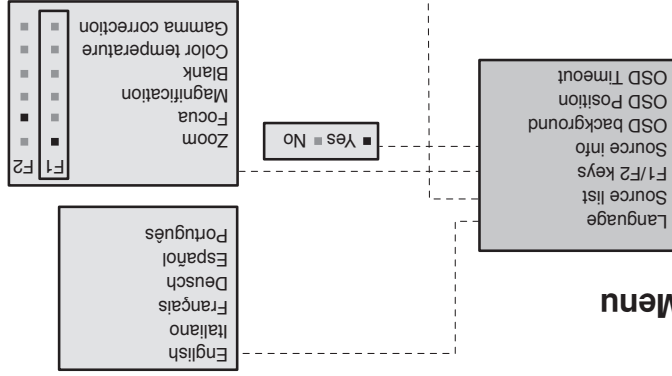

Memories

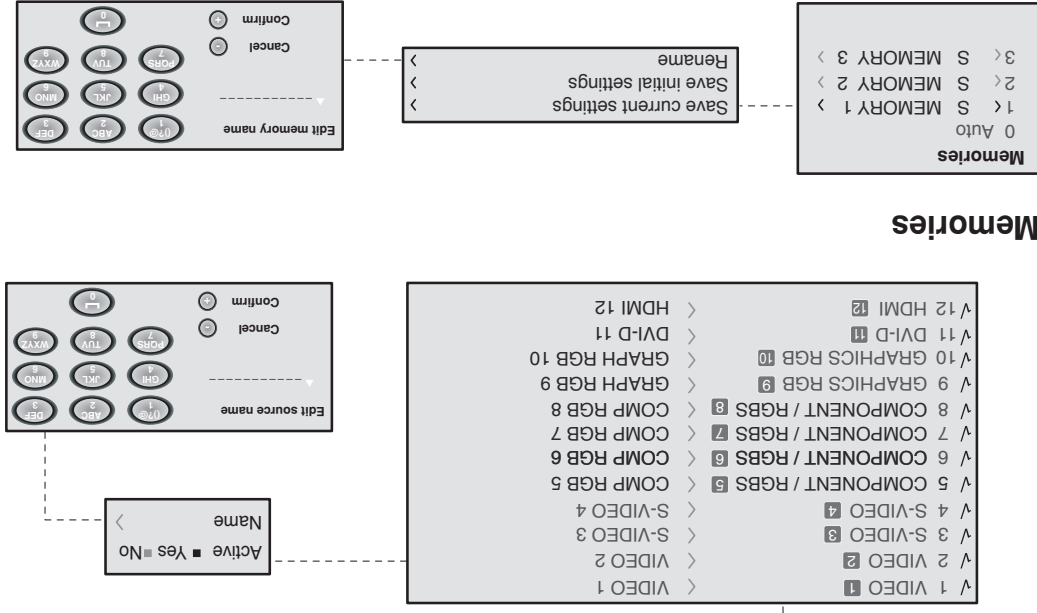

1	INTRODUCTION
2	IMPORTANT SAFETY INSTRUCTIONS
3	UNPACKING
6	Package contents
4	INSTALLATION
9	Switch on from stand-by
10	Switching off and returning to stand-by
6	CONNECTIONS
11	Composite video input
11	S-VIDEO Input
11	VGA input
11	RGB/CrCb Input
12	DVI™
12	HDMI™
12	Motorised projection screen output
13	232 interface connector
7	KEYBOARD PAD
8	REMOTE CONTROL

9	ON SCREEN MENU
15	Inputs
16	Main menu
16	Picture
18	Image
20	Set up
22	Menu
24	Memories
25	Info
25	Quick menus
25	Messages
10	CLEANING AND MAINTENANCE
11	TROUBLESHOOTING GUIDE
12	OPTIONAL ACCESSORIES
13	ADDITIONAL INFORMATION
28	A Technical specification
30	B Dimensions
31	C On screen menu layout

• Due to the constant product development, specifications and design might be subject to change without a notice.



SIM2 Multimedia is certified

SIM2 UK LTD • Steinway House Worth Farm,
Little Horsted Nr. Uckfield, East Sussex TN22 5TT
Phone +44.01825.750850 • Fax +44.01825.750851
www.sim2.co.uk • e-mail: kate.buckle@sim2.co.uk

SIM2 Deutschland GmbH • Gewerbepark, 17 D-35606 Solms
Phone 0800.800.7462 • Fax 0800.900.7462
www.sim2.com • e-mail: info.de@sim2.it

SIM2 USA Inc. • 10108 USA Today Way • 33025 Miramar FL - USA
Phone +1.954.4422999 • Fax +1.954.4422998
www.sim2usa.com • e-mail: sales@sim2usa.com

SIM2 Multimedia s.p.a. • Viale Lino Zanussi, 11 • 33170 Pordenone - ITALY
Phone +39.434.383.253-256 • Fax +39.434.383260-261
www.sim2.com • e-mail: info@sim2.it

